

# Universal Conversion Frame

Part # Ovation CU-250, Helix Wide Frame, CU-256, Encore CU-380



## Step by step installation

- Step 1 – Removal of Existing Dispenser
- Step 2 – Install Drip Tray
- Step 3 – Overlay Conversion Frame
- Step 4 – Mount Conversion Frame
- Step 5 – Plumb Dispenser

If changing the dispenser brand or model, use a brand new conversion frame. After a collision or drive-off, check the frame for damage. Replace it, DO NOT repair.

### Annual Maintenance Guidelines

Check for chips or damage to the frame's paint. Re-coat exposed areas with Ameron AmerShield epoxy. Check all nuts / bolts that they are completely secured and that no nuts have backed off. Cover all anchor bolts with Bravo supplied black plastic cap. This will aid in preventing corrosion.

Includes: conversion frame, drip tray, anchor covers

Safety First. S. Bravo Systems, Inc. recommends adherence to standard safety procedures and precautions provided by your company and to follow the regulations and compliances by OSHA, local, state and federal regulations regarding the use of this product.



**NOTE:** Verify that the installed product meets the American Disabilities Act. The highest operable part should be located no higher than 48" inches above the floor as long as there are no obstructions.



# Removal of Existing Dispenser, Install Drip Tray

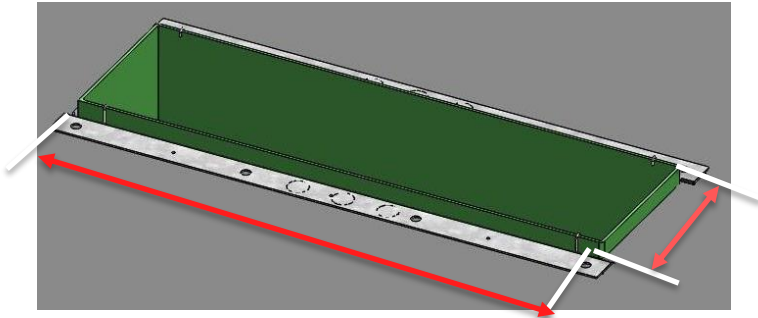

Fig.1

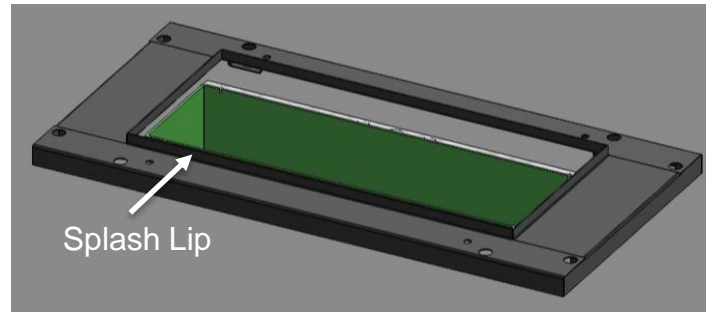

Fig.2

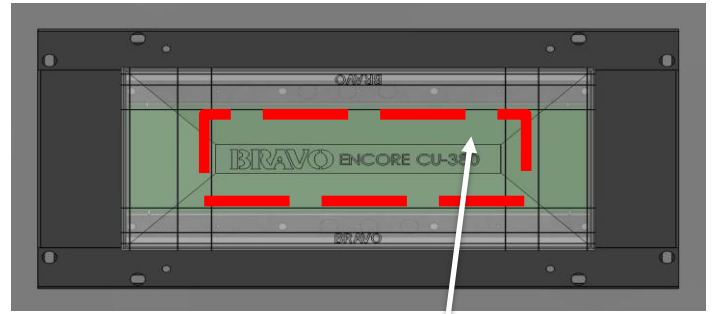
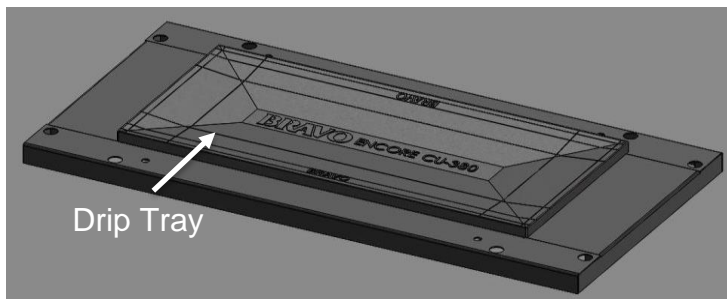

Fig.3

Cut mark should be minimum 1" smaller overall in length & width than UDC inside opening.

## Step 1 – Removal of Existing Dispenser

1. Remove existing dispenser from its mounting points.

## Step 2 – Install Drip Tray

1. Measure the inside length and width of the opening of the existing UDC. Evaluate whether the opening will be concentric or offset. (Fig.1) Use this information to plan accordingly.
2. Place the metal conversion frame on top of the UDC.
3. Place the drip tray over the metal conversion frame. Mark the cutting line and verify the angles are sized properly to redirect any possible leaks into the UDC. Be sure to leave 1" minimum in all directions to allow the drip tray to contain any fluid into the UDC.
4. Use a utility knife to cut an opening on the plastic tray. (Fig. 3)



# Overlay and Mount Conversion Frame, Plumb Dispenser

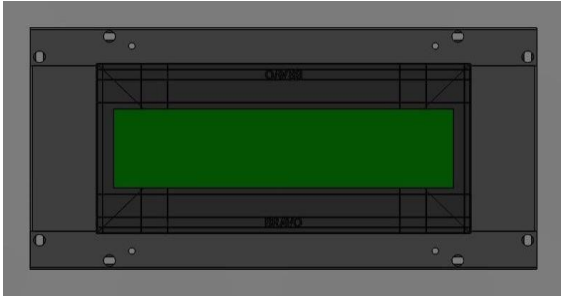

Fig.5

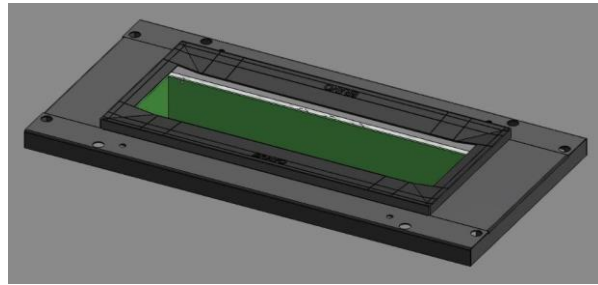

Fig.6

## Step 3 – Overlay Conversion Frame

1. Once the drip tray has been cut to the proper dimensions install the tray over the conversion frame's water splash lip. (Fig. 5)
2. If there is any interference from conduit and piping, the tray may be trimmed. (Fig.6)

## Step 4 – Mount Conversion Frame

1. Align and secure the universal conversion frame to the island / concrete with minimum 1/2"  $\varnothing$  diameter bolts. A minimum of eight (8) anchor bolts must be secured directly to concrete. Use provided plastic caps to plug all concrete anchoring bolt holes after they are fastened. Concrete anchoring bolts must not be corroded or compromised and should be embedded adequately. Follow your anchor bolt product manual or manufacturers' recommendations to install them properly.

## Step 5 – Plumb Dispenser

1. Pre-plumb all product inlets and vapor recovery lines with offsets and/or rigid pipe and elbows as necessary. Adjust electrical conduits to line up with the new dispenser as necessary.
2. Position and bolt down the dispenser to the conversion frame with the anchor bolts provided.

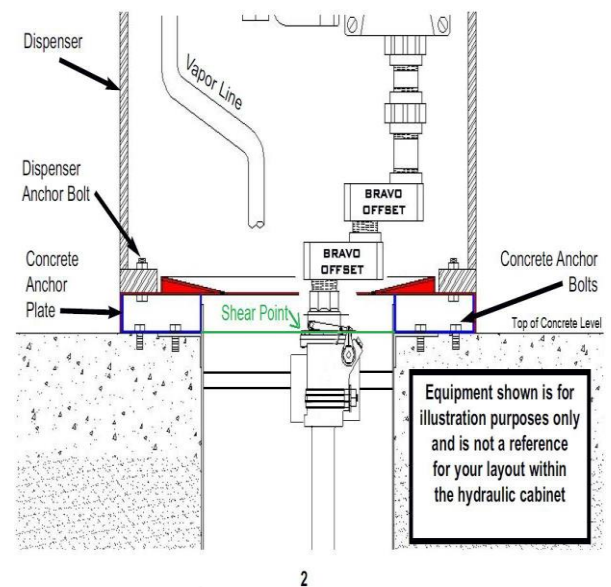



# WARRANTY

All Bravo products MUST be installed by a Bravo Certified contractor. Information contained in all Bravo literature is subject to change without notice. Bravo does not assume responsibility for liability for loss, damage or expenses resulting from installation, operation use or maintenance from this manual. By installing this product, you agree to S. Bravo Systems warranty terms.

## LIMITED WARRANTY

All Bravo products MUST be installed by a Bravo Certified contractor. Information contained in all Bravo literature is subject to change, to ensure you are viewing the current literature located on the Bravo website. Bravo does not assume responsibility for liability for loss, damage or expenses resulting from installation, operation use or maintenance from this manual. By installing this product, you agree to S. Bravo Systems, Inc's warranty terms. All Bravo products are subject to complete warranty information located on the S. Bravo Systems; Inc. website located at [www.sbravo.com](http://www.sbravo.com).

Trent Caster  
Western Regional Sales Manager  
[tcaster@sbravo.com](mailto:tcaster@sbravo.com)  
303.359.8862

Bob Hyatt  
Eastern Regional Sales Manager  
[bhyatt@sbravo.com](mailto:bhyatt@sbravo.com)  
239.888.6565

AK, AR, AZ, CA, CO, HI, ID, LA,  
MS, MT, NM, NV, OK, OR, WEST TN, TX, UT, WA, WY

AL, CT, FL, GA, IA, IL, IN, KS, KY, MA, ME, MI, MD, MO, NC,  
ND, NH, NJ, NY, OH, PA, SD, SC, EAST TN, VA, VT, WI, WV



## INNOVATIVE SOLUTIONS FOR SECONDARY CONTAINMENT

Commerce, CA | Lexington, TN  
800.282.7286 | [www.sbravo.com](http://www.sbravo.com)



When using and installing Bravo products, please consult local, state and federal regulations. Installers of Bravo products must be Bravo-certified.

