

# next<sup>®</sup>

S E R I E S

## 4 Bolt NEXT Series Retrofit Fitting

**PATENT PENDING**



Trent Caster  
Western Regional Sales Manager  
[tcaster@sbravo.com](mailto:tcaster@sbravo.com)  
303.359.8862

Bob Hyatt  
Eastern Regional Sales Manager  
[bhyatt@sbravo.com](mailto:bhyatt@sbravo.com)  
239.888.6565

AK, AR, AZ, CA, CO, HI, ID, LA,  
MS, MT, NM, NV, OK, OR, WEST  
TN, TX, UT, WA, WY

AL, CT, FL, GA, IA, IL, IN, KS, KY, MA, ME, MI,  
MD, MO, NC, ND, NH, NJ, NY, OH, PA, SD, SC,  
EAST TN, VA, VT, WI, WV

### Bravo NEXT Series Certification

All Bravo certified installers must also be NEXT Series certified.

PATENT PENDING



[Bravo](#)

**NEXT Series Kit**

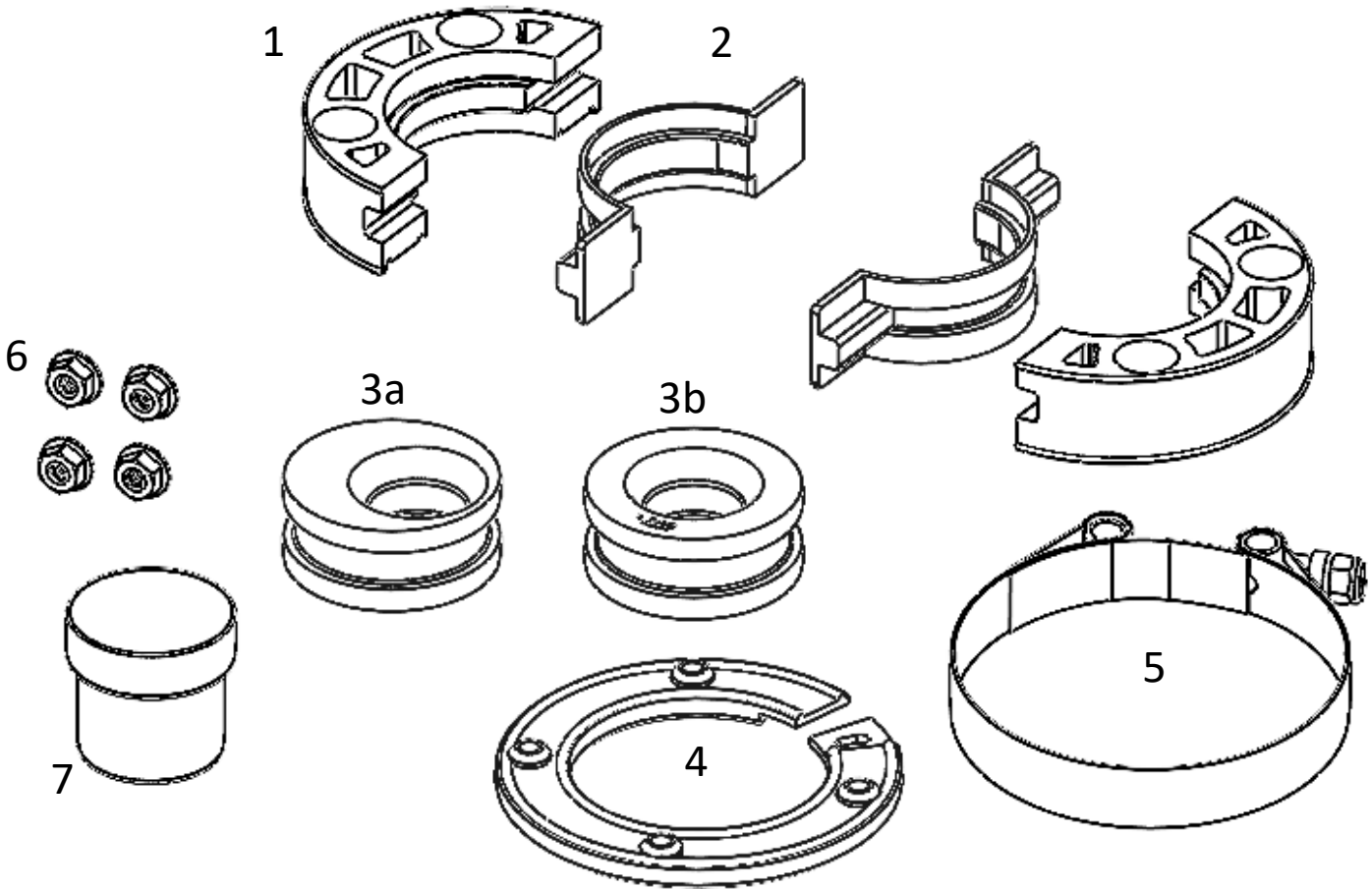

1. Split Mounting Ring (1)
2. Inner Disk Gasket (1)
3. 3a Offset Pipe Seal (1), 3b Concentric Pipe Seal (1)
4. Mounting Ring Gasket (1)
5. Clamp (1)
6. Replacement Flange Nuts (4)
7. Pack of Bravo Grease (1)
8. Pack of Gloves (1) (not shown)

**TOOL KIT – NXT-TK-B**

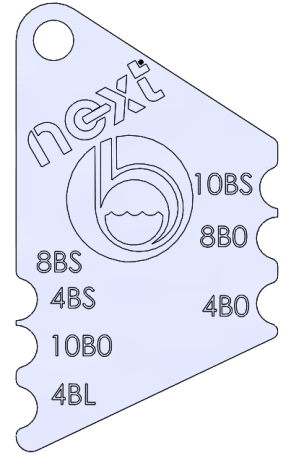
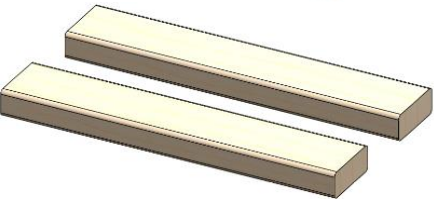
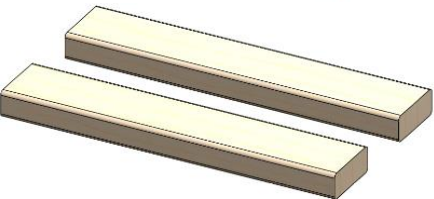
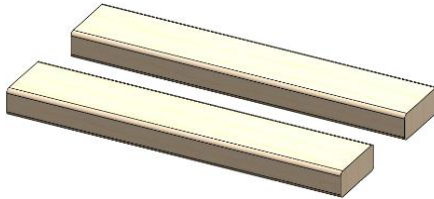
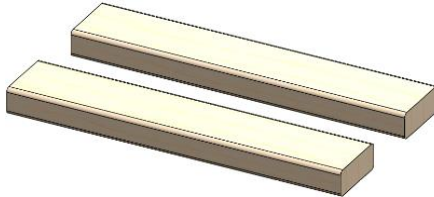
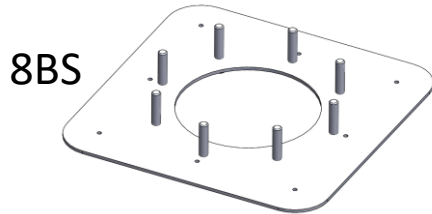
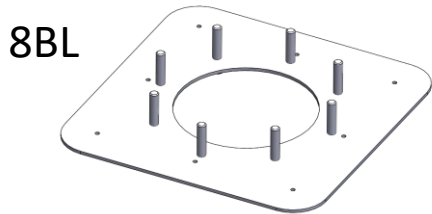
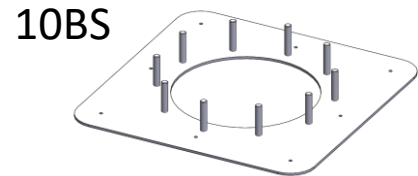
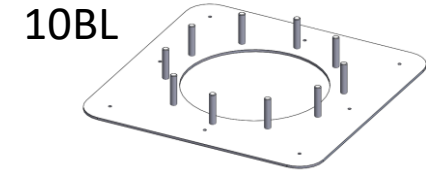

3.5"

3.25"

3"

2.5"

## **Recommended Tools**

1. 7/16" Deep Socket
2. 3/8" Drive
3. Bravo Grease
4. Bravo BS-01 polyurethane sealant
5. Caulking Gun
6. Rags
7. Acetone

**STEP 1**

**Preparing Sump**

1. Remove dispensers from island (if needed)
2. Thoroughly clean mounting walls
3. Remove any previous installed product (make sure all debris is removed to ensure fitting is flush with wall)
4. Inspect wall studs for usability
5. Prepare wall for installation (clean with acetone)

**STEP 2**

- a) Locate the Split Wall Gasket
- b) The side of the Split Wall Gasket without the raised nipple feature for the studs, goes against the wall
- c) Apply a bead of polyurethane sealant between the wall and the gasket
- d) Push the gasket onto the studs, seating it flush against the sump wall



**STEP 3**

- a) Apply grease liberally to the Pipe Seal and pipe
- b) Install Pipe Seal onto the pipe

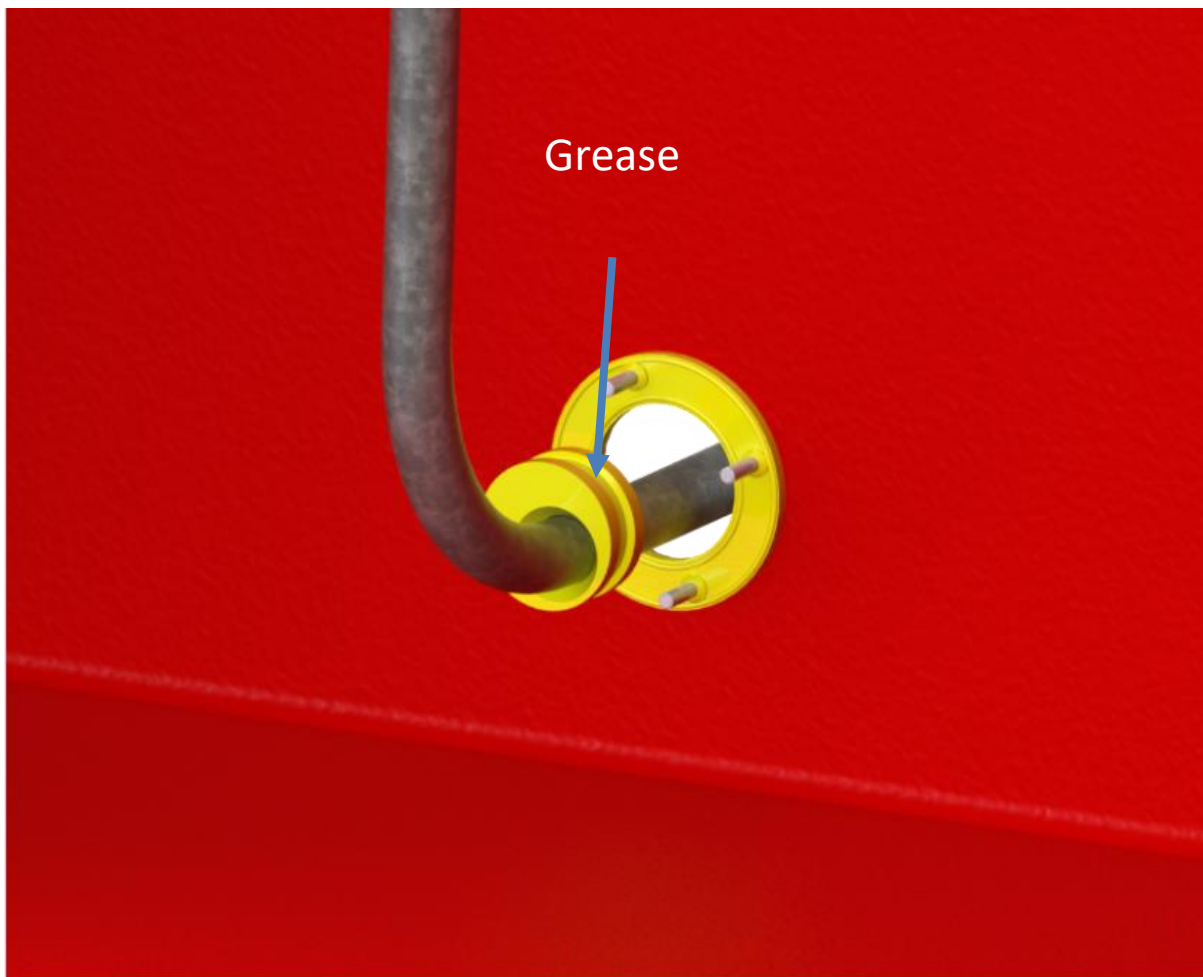

**STEP 4**

- a) Place the Mounting Ring over the Pipe Seal
- b) Install the Clamp loosely over the Mounting Ring near the sump wall

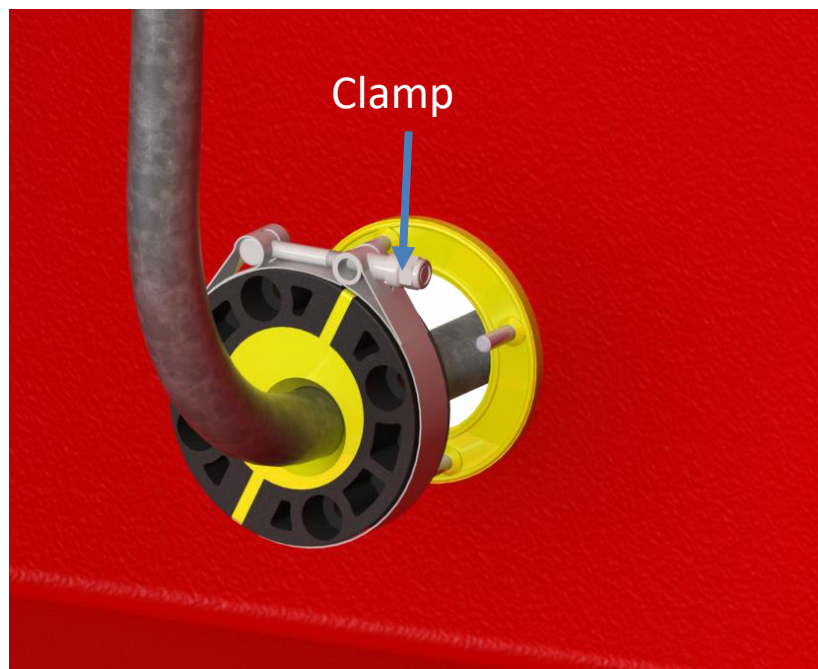

**STEP 5**

- a) Rotate the fitting assembly to line up the Mounting Ring with the studs and seat entire fitting assembly flush to the sump wall
- b) Install all flange nuts to seat the fitting to the wall
- c) Tighten the Clamp to full compression (15-17 ft #)
- d) Tighten all flange nuts in a star pattern to full compression
- e) Inspect that all bolts and nuts are tight and there are no gaps between any of the sealing surfaces
- f) Clean up any excess sealant
- g) Test sump for leaks

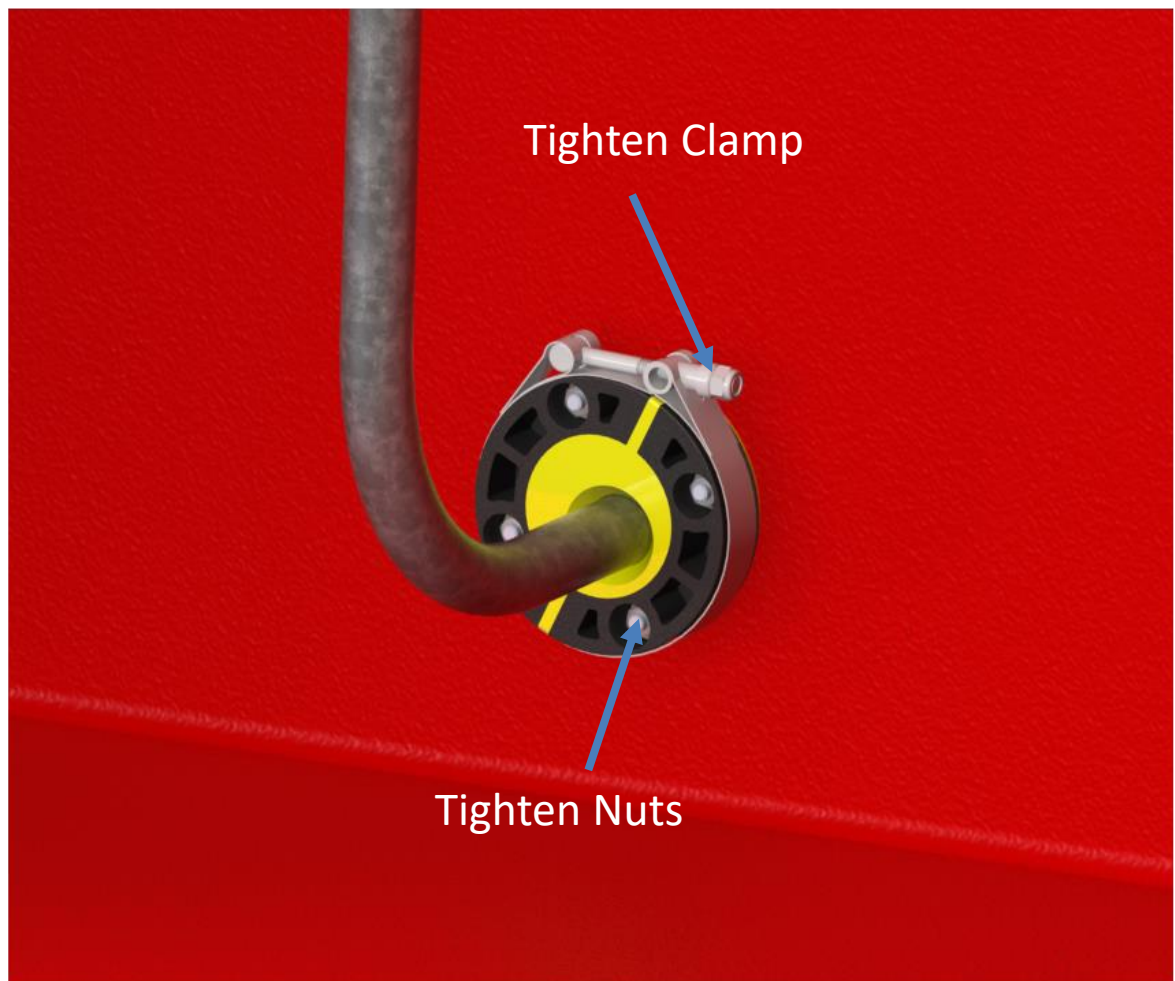

## ROUND SUMP ADAPTER

- a) Cut the round sump adapter square
- b) Rotate so the adapter matches the round profile
- c) Apply a ¼" layer of sealant to the wall between the studs
- d) Slide the adapter over the studs so flat side is against wall
- e) Apply a ¼" layer of sealant to the adapter
- f) Slide the wall gasket over the studs
- g) Proceed with remainder of fitting installation

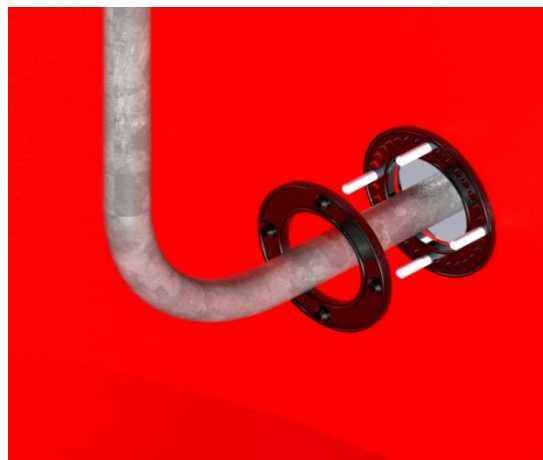
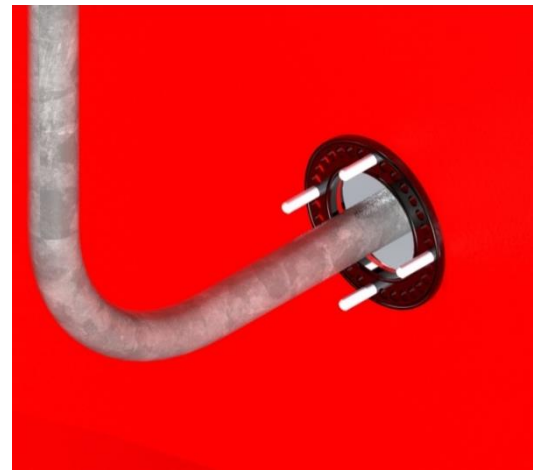
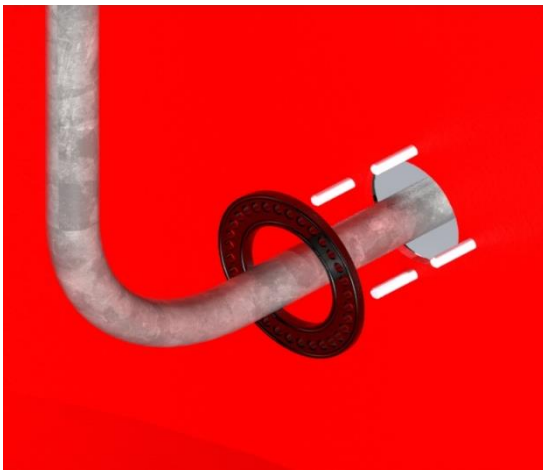

## REPLACEMENT PARTS

### ACCESSORIES

NXT-SE-10	Next Stud Extender (for Short Studs)10 Pack
NXT-TK-B	Next Tool Kit Bolted.
NXT-FN-25	Flange Nut 1/4-20 25 Pack
PS-290	PolyUrethane Sealant 290 ML

### 4 Bolt Standard Replacement Parts

NXT-C-04B0-1	Clamp for 4 Bolt Standard Next fitting
NXT-C-04B0-5	Clamp for 4 Bolt Standard Next fitting 5 Pack
NXT-PS-07-04B0-1	Pipe Seal 3/4" Galvanized Conduit 4 Bolt Standard, Center and Offset
NXT-PS-07-04B0-5	Pipe Seal 3/4" Galvanized Conduit 4 Bolt Standard, Center and Offset 5 pack
NXT-PS-07R-04B0-1	Pipe Seal 3/4" PVC Coated Conduit 4 Bolt Standard, Center and Offset
NXT-PS-07R-04B0-5	Pipe Seal 3/4" PVC Coated Conduit 4 Bolt Standard, Center and Offset 5 pack
NXT-PS-10-04B0-1	Pipe Seal 1" Galvanized Conduit 4 Bolt Standard, Center and Offset
NXT-PS-10-04B0-5	Pipe Seal 1" Galvanized Conduit 4 Bolt Standard, Center and Offset 5 pack
NXT-PS-10R-04B0-1	Pipe Seal 1" for PVC Coated Conduit 4 Bolt Standard, Center and Offset
NXT-PS-10R-04B0-5	Pipe Seal 1" for PVC Conduit 4 Bolt Standard, Center and Offset 5 pack

### 8 Bolt Standard Replacement Parts

NXT-C-08B0-1	Clamp for 8 Bolt Standard Next fitting
NXT-C-08B0-5	Clamp for 8 Bolt Standard Next fitting 5 Pack
NXT-RID-08B0-1	Next Inner Disk Replacement 8 Bolt Standard
NXT-RID-08B0-5	Next Inner Disk Replacement 8 Bolt Standard 5 Pack
NXT-PS-30-08B0-1	Pipe Seal for 3" Pipe 8 Bolt Standard
NXT-PS-30-08B0-5	Pipe Seal for 3" Pipe 8 Bolt Standard 5 pack

### 10 Bolt Standard Replacement Parts

NXT-C-10B0-1	Clamp for 8 Bolt Standard Next fitting
NXT-C-10B0-5	Clamp for 8 Bolt Standard Next fitting 5 Pack
NXT-RID-10B0-1	Next Inner Disk Replacement 10 Bolt Standard
NXT-RID-10B0-5	Next Inner Disk Replacement 10 Bolt Standard 5 Pack

### Pipe Seal Rigid for 8 & 10 Bolt Next Fittings

NXT-PS-20-10B-1	Pipe Seal for 2" Pipe 8 & 10 Bolt
NXT-PS-20-10B-5	Pipe Seal for 2" Pipe 8 & 10 Bolt 5 pack
NXT-PS-20L-10B-1	Pipe Seal for 2" LCX Pipe 8 & 10 Bolt
NXT-PS-20L-10B-5	Pipe Seal for 2" LCX Pipe 8 & 10 Bolt 5 pack
NXT-PS-30-10B-1	Pipe Seal for 3" Pipe 8 & 10 Bolt
NXT-PS-30-10B-5	Pipe Seal for 3" Pipe 8 & 10 Bolt 5 pack
NXT-PS-40-10B-1	Pipe Seal for 4" Pipe 8 & 10 Bolt
NXT-PS-40-10B-5	Pipe Seal for 4" Pipe 8 & 10 Bolt 5 pack

### Pipe Seal Flex Pipe for 8 & 10 Bolt Next Fittings

NXT-PS-2.0A-10B-1	Pipe Seal for 1-1/2" APT XP Pipe 8 & 10 Bolt
NXT-PS-2.0A-10B-5	Pipe Seal for 1-1/2" APT XP Pipe 8 & 10 Bolt 5 pack
NXT-PS-2.0E-10B-1	Pipe Seal for 1-1/2" Environ, OPW Flexworks Pipe 8 & 10 Bolt
NXT-PS-2.0E-10B-5	Pipe Seal for 1-1/2" Environ, OPW Flexworks Pipe 8 & 10 Bolt 5 pack
NXT-PS-2.2A-10B-1	Pipe Seal for 1-3/4" APT XP Pipe 8 & 10 Bolt
NXT-PS-2.2A-10B-5	Pipe Seal for 1-3/4" APT XP Pipe 8 & 10 Bolt 5 pack
NXT-PS-2.5E-10B-1	Pipe Seal for 2" Environ, OPW Flexworks Pipe 8 & 10 Bolt
NXT-PS-2.5E-10B-5	Pipe Seal for 2" Environ, OPW Flexworks Pipe 8 & 10 Bolt 5 pack

### Limited Warranty

S. BRAVO SYSTEMS, Inc. (S. BRAVO) warrants to the original purchaser ("Original Owner") that all containment systems sold by S. BRAVO to Original Owner, when properly installed by an

S. Bravo certified installer ("Installer") and maintained in strict compliance with S. BRAVO'S instructional guidelines, shall be free from defects in material and workmanship for a period of one (1) year from the date of purchase ("Warranty Period").

S. BRAVO SYSTEMS, Inc., a California Corporation (S. BRAVO), further warrants to the Original Owner that the fiberglass component of an S. BRAVO manufactured containment product will not fail as a result of internal or external corrosion for a period of thirty (30) years (except as further limited in Section A1a below) from the original date of purchase when used as intended for the containment of fuels under the following conditions.

A. The S. BRAVO containment system may consist of any of the following S. BRAVO manufactured products: fiberglass tank or turbine sump, fiberglass dispenser sump, fiberglass transition sump or fiberglass new construction entry fittings; and

1a. "E" Series (Economy) containment sumps maintain a limited E Series Express Warranty from internal and external corrosion for a period of ten (10) years.

B. S. BRAVO fiberglass entry fittings must only be used in conjunction with fiberglass pipe (either Red Thread IIA or Dualloy 3000/L or 3000/LCX), steel pipe, galvanized pipe or PVC coated galvanized steel pipe; and be bonded to a fiberglass wall.

C. The FPE-Series, FLX-Series and Direct replacement fiberglass retrofit fittings for flexible pipe are excluded from the Express warranty agreement statement above. The FPE-Series FLX-Series and direct replacement fiberglass retrofit fittings maintain Limited Flex Series Express Warranty of three (3) years.

D. The Bravo containment system components must have been properly installed by an

S. BRAVO certified installer in accordance with S. BRAVO instructional guides.

This limited warranty covers replacement of the containment system only and does not include the cost of removal or installation. S. BRAVO is not liable for variations in color, texture or appearance of the containment system after replacement, nor does it warrant that replacement systems will be identical in all respects with any prior systems.

Should S. BRAVO determine, in its sole and absolute discretion, that any failure cannot be corrected and cured by replacing the containment system, the remedy for breach of these warranties shall be an amount equal to the original cost of the product.

This limited warranty shall not be applicable and shall be void if the Original Owner or any third party removes or replaces the originally-installed containment system without written approval of S. BRAVO, which prior approval shall not be unreasonably withheld but may be conditioned upon a S. BRAVO representative's being present at such removal.

In order to make a claim under this limited warranty, the Original Owner, or its representative, must notify S. BRAVO, in writing, of the nature of the claimed failure within thirty (30) days of discovery of such failure or damage. Upon receipt of such notice, S. BRAVO shall, within a reasonable time, inspect the installation at issue and determine the nature of the alleged failure.

This limited warranty may not be modified without prior written approval of S. BRAVO. If any provision of this limited warranty is held invalid or unenforceable, in whole or in part, the remaining portions of this limited warranty shall be severable and remain in effect.

No agent, independent contractor, employee, or representative of S. BRAVO, including any approved installer, has any authority to bind S. BRAVO to any affirmation, representation, guarantee or warranty concerning the goods affected by this limited warranty. Unless an affirmation, representation, guarantee or warranty made by an S. BRAVO representative is specifically included within this limited warranty, it will not be enforceable. No delay or omission on the part of S. BRAVO, or its agents, representatives, employees, or independent contractors in exercising any right or remedy provided herein shall constitute a waiver of such right or remedy. This limited warranty may not be transferred or assigned to a third party without the prior written consent of S. BRAVO.

This limited warranty is made and entered into in the State of California, and shall in all respects be interpreted, enforced and governed under the law of that state. This limited warranty shall supersede all prior communications, either written or oral, and all previous agreements, if any, between the parties with respect to any subject matter hereof, and shall set forth the complete understanding of the parties with respect thereto.

**THIS LIMITED WARRANTY IS IN LIEU OF ALL WARRANTIES, WHETHER WRITTEN, ORAL, EXPRESS OR IMPLIED, INCLUDING ANY IMPLIED WARRANTY OF MERCHANTABILITY OR OF FITNESS FOR A PARTICULAR PURPOSE AND ALL OTHER OBLIGATIONS AND LIABILITIES ON THE PART OF S. BRAVO.**

The foregoing shall constitute S. BRAVO's sole liability to the Original Owner and under no circumstances shall S. BRAVO be responsible for any special, incidental, or consequential damages. Some States do not allow the exclusion or limitation of incidental or consequential damages, so the above limitation or exclusion may not apply to particular circumstances or transactions. This warranty gives you specific legal rights, and you may also have other rights which vary from State to State.



**Warranty**

5-Year Limited Parts Replacement Warranty

**When using and installing Bravo products, please consult local, state and federal regulations**

800.282.7286

[www.sbravo.com](http://www.sbravo.com)

Commerce, CA | Lexington, TN

