

INSTALLATION INSTRUCTIONS ***FOR SOLID DOUBLEWALL TANK SUMPS***

Solid (1 joint) Tank Sump Models:

B400-D-AB

B400-D-AB-MW

B400-D-AB-MB

B400-D-AB-WT

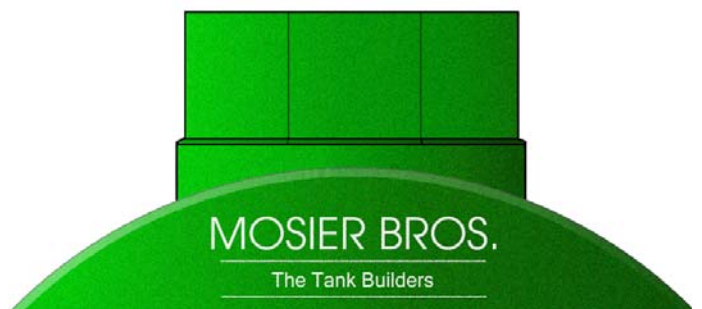

S. Bravo Systems, Inc.
2929 Vail Ave. - Commerce, CA 90040
(323) 888-4133 - FAX: (323) 888-4123
www.SBravo.com



MANDATORY

The B-400 Doublewall Solid Sump Series from S. Bravo Systems, Inc. MUST be installed by, and only by, **Bravo Certified Tank Sump Installation Contractors**. Details can be found at www.sbravo.com/cert.htm

READ THESE INSTRUCTIONS - KEEP FOR FUTURE REFERENCE	
TABLE OF CONTENTS	
DRY FITTING SUMP & EQUIPMENT.....	p. 4
X) Tall Collar and Short Collar Pre-Installation Directions.....	p. 5
A) Preparing the Tank Collar and Tank Sump Body.....	p. 6
B) Joining the Tank Sump Base to the Tank Collar.....	p. 7-8
C) Fiberglassing Tank Sump Base to Tank Collar.....	p. 9-10
D) Testing Base to Collar Fiberglass Install.....	p. 11
Install & Test Penetration Fittings.....	D.3-D.5
E) Mandatory Air Integrity Test.....	p. 12
F) Vacuum / Hydrostatic Filling.....	p. 13-14
G) Advanced Leak Detection Procedure.....	p. 15-16
H) Attaching the Manometer.....	p. 17-18
I) Concrete and Backfill Guidelines.....	p. 19



Filling Bravo Systems Double Wall Products with Brine (saline) solution will void the product warranty. You must use only Bravo-Supplied Interstitial Fluid.

- Closely adhere to all directions and warnings indicated on the product or contained in these instructions. This includes following the OTHER manufacturers recommendations and Installation guidelines including -but not limited to- equipment associated or in contact with, Bravo Systems Products.

- Warranty is void if there is any evidence of modification, abuse, negligence or improper installation.

SAFETY FIRST! S. Bravo Systems, Inc. urges you to carefully adhere to the normal safety procedures and precautions followed by your company. Please follow the mandates and compliances decreed by OSHA, local, State and federal regulations regarding the use of this product.

WARRANTY

All containment systems sold by S. Bravo Systems, Inc. are warranted to be free from defects in material and workmanship for a period of one year from date of purchase. This warranty will be limited to the repair and replacement of Bravo parts only and will exclude all claims for labor or consequential damage. No other express warranties given and no affirmation of S. Bravo Systems, Inc., or its agents and/or representatives, by words or action, will constitute a warranty. IT IS EXPRESSLY AGREED THAT THIS WARRANTY WILL BE IN LIEU OF ALL WARRANTIES OF FITNESS AND IN LIEU OF THE WARRANTY OF MERCHANTABILITY.

This warranty is void if there is any evidence of modification, abuse, negligence, or improper installation. If any fittings or components, other than S. Bravo Systems approved fittings or components, are used in conjunction with any S. Bravo Systems product, the warranty pertaining to these products is immediately void.

INCLUDED COMPONENTS!

Recommended Tools

(NOT PROVIDED)

Power/air Sanders. Acetone to clean up tools/applicators. Power Cutting Tools. An extra Barrel Roller. Extra Paint Roller. Hand pump.

T-FS-SAND-KIT

5/8" sanding disc backs and centralizers for all Bravo Systems Fittings

SVA-BARB per sump

VAC-KIT-D-AB per site



HYDROSTATIC ONLY!! MANOMETER KIT (PER SUMP)

- Interstitial fluid	TOTAL HEIGHT
- Standard Manometer	4' = 5 gal
- Manometer Bracket	5' = 6 gal
- Factory-Installed	6' = 7 gal
Nylon tubing	7' = 8 gal
w/20"Hg Vacuum on interstice	
w/Combination Pressure/Vacuum Gauge	

RESIN KIT PER SPLIT SUMP (2 Joints)

Inside & Outside

2.5 Gal of Resin. 1 Qt. of Paste. Resin Catalyst. Paste Catalyst. Mixing Buckets. 4 Pairs Nitrile Gloves. One 90' Roll of Fiberglass Mat. An extra 30' roll of fiberglass mat. Four 4-1/2" Roller Covers. Two sheets of 60-grit Sandpaper. Four Sheets Blue Shop Towels. Manometer Kit. Interstitial fluid.

TOOL KIT (per site)

One 4" Paint Roller, One Metal Paste Mixer, One Paint Stirring Stick, One 4" Putty Knife, One Metal Chamfer Roller, One 5 quart mixing bucket. One 250' by 1" Roll of Masking tape per 2 Sumps. MSDS for materials.





BEFORE PENETRATING FIBERGLASS WALLS ENSURE THAT EACH DOUBLE WALL FIBERGLASS SUMP IS HOLDING VACUUM



It is **REQUIRED** to visually check the Vacuum gauge on each and every Bravo Systems Double Wall product and write on its FAX report **Vacuum level**, **name of observer**, and **date** for every DoubleWall Sump.

WARRANTY IS VOID:

IF ANY OF THE FOLLOWING OCCUR

- A)** There is a failure to comply with the Required written report guidelines as stated above.
- B)** Double Wall Products are DOUBLE-STACKED, stored or shipped in a negligent way.
- C)** Any packaging or wrapping materials are removed before the item reaches It's destination.
- D)** Double Wall Sump Products, Failure to call Bravo Systems If Vacuum level on product is less than 12" HG (Vacuum) (323) 888-4133, refer to sump for further details.
- E)** Double Wall Sump Products are tested per the SB989 Testing procedures. The interior of these sumps must **NOT** be filled with liquid to any level.
- F)** Double Wall Sumps are filled with an unapproved interstitial fluid, or if adhesives or sealants are used that are not Bravo-approved.

If there is any indication or suspect damage, you must mark the freight paperwork "*Suspect Freight Damage*" as directed by your Contractor Warranty sheet.

EQUIPMENT DRY-FIT

- BEFORE INSTALLING PENETRATION FITTINGS
- BEFORE CUTTING OPEN SUMP INTERSTICE

**DRY-FIT YOUR SUMP PIECES AND
INTERNAL EQUIPMENT.**

**PLAN YOUR INSTALLATION AND MAKE
SURE EVERYTHING FITS, AND WILL FIT
LATER DURING INSTALLATION.**



**DO NOT PLACE FIBERGLASS PIPING SUMP(S) ON
THE COLLAR AND ATTEMPT TO SEAL THE JOINT(S).
READ STEP-BY-STEP INSTRUCTIONS FIRST.**

**DO NOT drop the sump body or tank collar on the ground or roll it to its
destination or forcefully dry fit the sump body on the tank collar.
Secure and protect sumps from high wind conditions.**

⚠ CAUTION

**If using electric powered-tools move piping sump a safe distance from piping,
tank and any other source of flammable liquids or vapors before trimming.
Failure to do so may result in serious injury or death. When installing on
existing tank(s), use a Vapor Detector around tank(s) before install.**

FOR TALL BASE/COLLAR ONLY

**BEFORE INSTALLING PENETRATION FITTINGS
ENSURE THAT THE BASE/TANK COLLAR AND SUMP BODY ARE
HOLDING VACUUM.**

If the gauge is **Below 12 inches of mercury (Hg/Vacuum)**
you must hold the Sump at **20 INCHES OF MERCURY** for no less than **24 hours**.

If the gauge is **AT OR ABOVE 12 INCHES OF MERCURY**, proceed to **Step X.1**

X.1 - After your Primary tank(s) have arrived, ensure the tank collar, joint of the tank collar, and piping sump, is clean of debris. Also visually inspect the parts provided by Bravo Systems for In-transit damage and/or missing parts. Continue to keep the components clean of debris throughout the steps shown in these Installation Instructions.

X.2 - Sweep away any gravel, dirt or debris around the **OUTSIDE** where the tank collar meets the tank so that you will be able to see possible leaks.

X.3 - Install Penetration Fittings per their respective Installation Instructions. You must NOT disturb the penetration fittings while the sealant/adhesive is drying. Allow for the maximum cure time as recommended by the manufacturer of the fittings before pressurizing & soaping to test for leaks.

IMPORTANT DO NOT FILL DOUBLE WALL PENETRATION FITTINGS
WITH FOREIGN MATERIALS, SEALANTS or ADHESIVES.

X.4 - If the Sump was holding Vacuum as described above, any leaks may be credited to the Installation of the Penetration Fittings. Install stub / dummy pipe in all the penetration fittings and use the factory provided Vacuum/Pressure gauge to pressure the sump to **4 PSI** and soap **ALL** fittings, inside and outside. **If foaming leaks are found**, repair or reinstall per manuf. Instructions.

FOR SHORT COLLARS

**YOU MUST ENSURE THAT THE TOP OF YOUR COLLAR IS CUT
SQUARE. IF IT IS, ABRASE AS OUTLINED IN SECTION A.**

**YOU WILL INSTALL THE PENETRATION FITTINGS ONLY AFTER THE
BODY HAS BEEN FIBERGLASSED TO THE COLLAR AND TESTED**

IMPORTANT MAKE SURE TO FILL OUT AND FAX YOUR WARRANTY FORMS
ATTACHED TO EACH DOUBLE WALL FIBERGLASS SUMP.
FAX TO 323-888-4133 TO ACTIVATE YOUR WARRANTY.

X.6 - PROCEED TO THE NEXT STEP TO BEGIN THE CUTTING AND GRINDING PROCESS TO
PREPARE FOR FIBERGLASSING THE BODY OF THE SUMP TO THE BASE/TANK COLLAR.

A - PREPARING THE COLLAR AND TANK SUMP BODY

Always wear gloves when handling piping sump components, and always wear eye protection when grinding, cutting, or applying resin to the components.

STEP BY STEP OVERVIEW

Determine overall Tank Sump height based on the plans for grade level. You will then perform the following actions in order:

NOTE: All steps to Abrade are inside and outside the Sump

- 1) If you have a Base/Collar (tall) Install your penetration fittings (Page 5)
If you have a short collar, skip to Number 3.
- 2) If you have a Base/Collar (tall) Cut the minimum 2" from top of the Base/Collar
- 3) Abrade 4" down from top of Collar, dust off, keep clean
- 4) Cut the bottom of the Body to attain the necessary overall height required to reach Grade specifications
- 5) Abrade 4" up from bottom of Body, dust off, keep clean
- 6) Carefully join the Body to Collar, Tape joint inside & out
- 7) Mix Paste with Catalyst and apply OVER the taped joint to smooth out wall transition in case of difference in Diameter
- 8) Fiberglass the Body to the Collar and let cure
- 9) lightly sand, and flow-coat the joint, inside & outside, let cure
- 10) Test the interstice: Pressure & Soap the Fiberglass job
- 11) If you have a Short Collar, Install your penetration fittings
- 12) After fitting installation, pressure & soap the fittings
- 13) Field Air Integrity Test: 4 PSI on interstice and wait one hour before beginning test. Mark time, monitor for one hour
- 14) Hydrostatic Filling and Advanced Leak Detection Procedure
- 15) Field Integrity Test: Mark liquid level and monitor one hour
- 16) Protect Tank Sump Reducer and Backfill

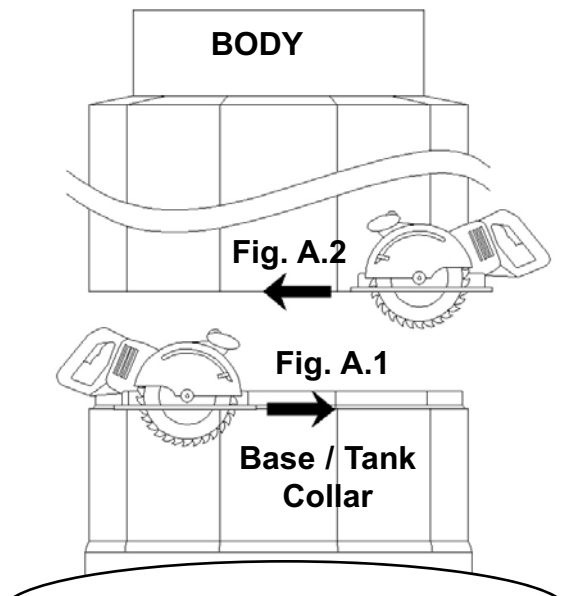

A.1 - Trim the **Top** of piping sump **Base/Collar** 2" from **TOP EDGE** only using a carbide tipped blade or masonry saw. Material must be cut square with a 1/4" +/- tolerance to open the double wall space 360° around sump. (Fig. A.1)

A.2 - Trim the **Bottom** of piping sump **BODY** the necessary amount to reach grade from **BOTTOM EDGE** only using a carbide tipped blade or masonry saw. Material must be cut square with a 1/4" +/- tolerance to open the double wall space 360° around sump. (Fig. A.2)

A.3 - Abrade with air-driven sander (Fig. A.3.1) 4 inches down from top edge of **Tank Collar - Inside and Outside** - until fiberglass surface can be seen clearly. (Fig. A.3.2) Dust off with shop brush and keep clean.

B - JOINING THE BASE TO TANK COLLAR

B.1 - Fit the clean Tank Sump **BASE** on the tank collar and ensure it is sitting squarely in place (Fig. B.1.1 - B.1.2). Ensure walls are fully abraded down to the glass fibers.

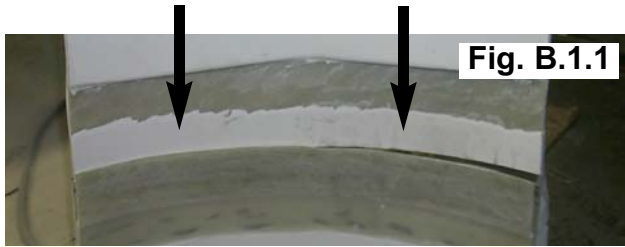

B.2 - Ensure Tank Sump **BASE** is centered, plumb and stationary prior to and during the application of masking tape and paste. **Alignment is critical.**

B.3 - You must remove the Schrader Cap from the Gauge assembly and screw on the **SVA-BARB (Schrader Valve Adapter w/Barb)** (see below) on all DoubleWall products that will be fiberglassed.

IMPORTANT

While Fiberglassing, curing, or sitting overnight, keep the **SVA-BARB** in place. This will relieve stress on the Interstice while the sumps are heating up or cooling off.

SAVE THESE PIECES, DO NOT LOSE THEM! Remove the SVA-BARB when ready to test.

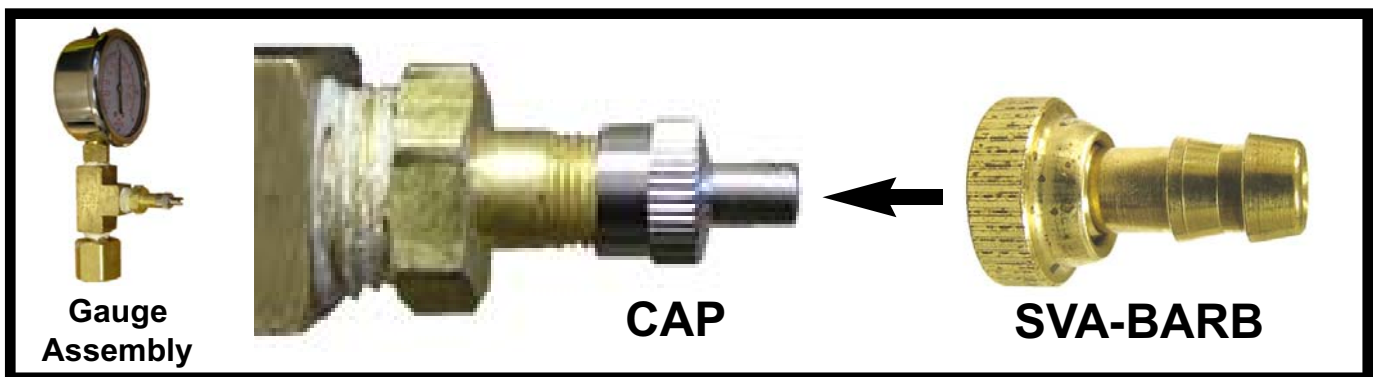

B.4 Apply provided masking tape to the joint edge overlapping the ends securely. Tape the inside and outside joint of the transition. Use extra if necessary. (Fig. B.4)

B.5 - Get your **Paste Kit** and tools together. Ensure surfaces inside and outside of the joint and surrounding walls are clean of debris and **COMPLETELY DRY!**



B.6 - Mix catalyst (**bottle with RED sticker**) and paste together in plastic mixing bucket (provided) with stir stick. Mix thoroughly until paste has changed in color and is consistent. (**Fig. B.6**)



NOTICE

CATALYST BOTTLE FOR PASTE HAS A RED STICKER

FOR SUMMER!!! 1/2 bottle per 1/4 Gallon of putty.

FOR WINTER !!! 1 bottle per 1/4 Gallon of putty.

WARNING



Wear protective goggles and a mask when mixing and applying resin or paste.

B.7 - Proceed to apply the mixed paste material to the sump joint, over the applied tape and over its edges to meet the fiberglass wall. Do not be sloppy. The more paste you smear past the tape, the more work you need to do to remove it later. **Step B.7 - B.7.3**



B.8 - Wait until the material (paste seal) physically hardens (cures), normally a minimum of One Hour @ or above 75 degrees fahrenheit. ***PIPING SUMP MUST NOT BE DISTURBED DURING THIS TIME TO AVOID MISALIGNMENT.***

B.9 - After exterior joint(s) have fully cured, mix paste and smoothly apply to the inside joint of the piping sump, over the tape and its edges, see **Fig. B.9**. Visually inspect the Joints that the paste has been applied to and look for gaps or delaminating. Ventilate sump accordingly, if mandated by local or federal regulations.

B.10 - After Paste has fully cured, grind down all previously abraded areas (**Fig. B.7.3**) and lightly touch up pasted area with additional paste as needed. Dust off abraded areas.



C - FIBERGLASSING THE BODY TO TANK COLLAR.

ENSURE THAT THE SUMPS ARE COMPLETELY DRY, FREE OF DEBRIS, ICE AND/OR SNOW. DO NOT HANDLE ANY FIBERGLASS SUMP WITH YOUR BARE HANDS.

C.1 - Pre-cut several dozen pieces of 6" wide fiberglass mat to lengths of 20-24". You will need **4 layers** of these fiberglass mat strips for the **INSIDE** and **OUTSIDE** joints of each piping sump.

C.2 - Mix together resin and catalyst with mix stick thoroughly.

NOTICE For **SUMMER!!** 1/4 bottle per 1/4 Gallon of resin.
For **WINTER!!** 1/2 bottle per 1/4 Gallon of resin.

C.3 - Use paint roller to apply resin generously to a smooth surface. Spread the resin so it 'wets out' an area larger than the strip of fiberglass mat. (Fig. C.3)

C.4 - Apply one layer of fiberglass mat to the resin and use the paint roller to add more resin to fully saturate it. (Fig. C.4)

C.5 - Lay down another strip of fiberglass mat, **staggering the new layer ONE INCH**. This means to offset the next fiberglass strip horizontally (lengthwise) 1" to the right. Roll more resin into the new strip to saturate it. (Fig. C.5)

C.6 - Repeat **Step C.5, offsetting another strip of fiberglass mat** and using the paint roller to add more resin to it until it is fully saturated. (Fig. C.6)

C.7 - Repeat once more **Step C.5** for a total of **4 layers**.

C.8 - Use a **Chamfer roller** to completely roll over the pre-soaked fiberglass strip while it is on the cardboard, horizontally and vertically, to run out any air bubbles. (Fig. C.6)

C.9 - Apply the fiberglass patch to the **OUTSIDE JOINT** of the piping sump centered on the joint. Apply saturated fiberglass strips all the way around the piping sump....**EVENLY OVERLAPPING EACH 2 FOOT STRIP 3 INCHES OVER THE LAST.** (Fig. C.9.1)

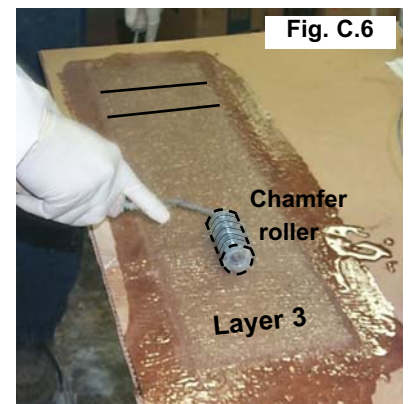
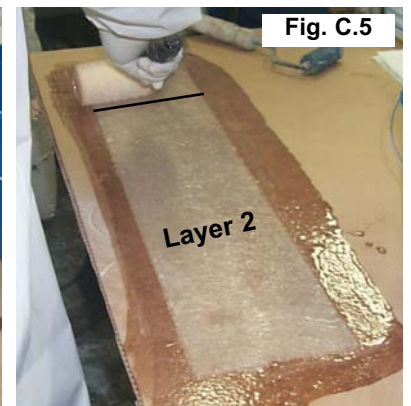
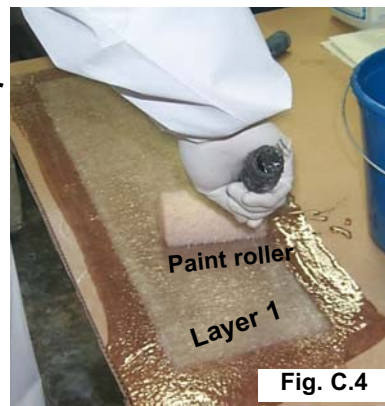
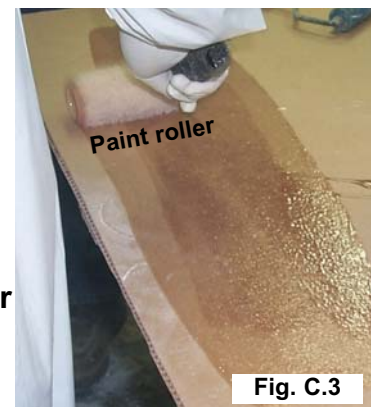

ONLY apply fiberglass strips horizontally (**ACROSS the piping sump, not up and down.**) The completed glass job should be air-free, seamless and ripple-free as shown in Fig. C.9.3.

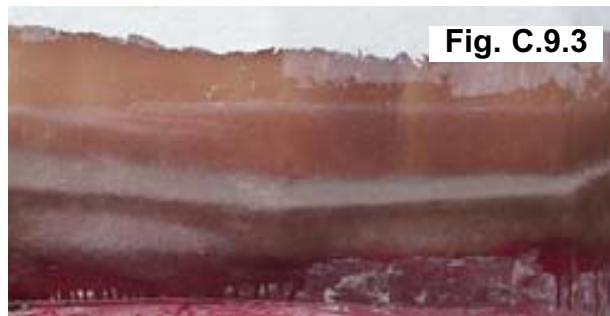

Roll over the fiberglass mat many times with a **Chamfer roller** (provided) on the **OUTSIDE JOINT** to make sure it is cleanly adhered to the fiberglass piping sump walls. Run the roller up and down to force any air out from under the fiberglass strip. (Fig. C.9.2)

C.10 - Repeat Steps C.4 to C.9 and apply fiberglass strips to the **INSIDE JOINT** of the piping sump. (Fig. C.10.1) For the **INSIDE** fiberglass strips use a **Barrel roller** to apply the strips to the curved surface. (Fig. C.10.2)



C.11 - Use a **Chamfer roller** to carefully roll over the applied fiberglass strips to run out any air bubbles. (Fig. C.11)

C.12 - Allow at least 4 hours at 75 Degrees to cure. During this time, continue on to other sumps.

C.13 - When all fiberglass applications have cured, sand them down **lightly with air-sander** or **roughly with coarse 40 - 60 grit sandpaper** all the way around the piping sump to knock down all excess fiberglass 'hair' and material. (Fig. C.13)



C.14 - Mix resin and apply with paint roller, completely covering the fiberglass material all the way around the piping sumps. Roll resin generously with paint roller. **DO NOT USE PUTTY KNIFE** or other scraping tool. The resin needs to be applied generously and evenly. (Fig. C.14)

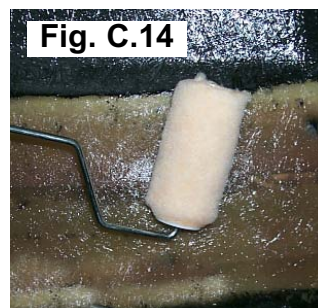

C.15 - Now install any/all equipment in the piping sump(s) that will not interfere with fiberglassing the top portion of the sump. Install all necessary equipment per local code & regulations. Follow installation instructions / recommendations / warnings provided by equipment manufacturer(s).

D - TESTING THE BASE/COLLAR INSTALL

Remove & save the **SVA-BARB** from the Gauge Assembly Schrader Valve (Refer to Step B.3)

D.1 - Sweep away any gravel, dirt or debris around the **OUTSIDE** of the piping sump, where the tank collar meets the tank so that you will be able to see possible leaks.

D.2 - Pressurize the interstice to 4 PSI and soap the fiberglass joint, inside and outside. If sump is holding, keep record.

D.3 - IF ANY LEAKS ARE FOUND!!

Look at edges and corners for pinhole leaks. **For large leaks, consult factory.**

A: Locate leak point(s) and mark with marker so you can locate it / monitor it.

B: Repair or reinstall doublewall penetration fittings according to your doublewall penetration fitting manufacturers' Installation / Maintenance Instructions.

C: Abrade a 2" diameter area centered on the leak point until natural resin/fiberglass material can be seen. Dust with shop brush or compressed air and do not use shop towels or acetone on the abraded area(s). Then apply a 3-layer strip of 2" x 2" resin-saturated fiberglass mat squarely on the abraded area.

D: Roll out any air bubbles with chamfer roller. Let cure.

E: After cure, knock down fiberglass hairs, and apply another flow coat of resin only (**Step C.14**). Apply any extra resin to repaired leak point(s) while still wet. Let cure for a minimum of 4 hours @ or above 75° F.

ALLOW ANY REPAIRS TO FULLY CURE BEFORE TESTING SUMP AGAIN

DO NOT FILL DOUBLE WALL PENETRATION FITTINGS WITH FOREIGN MATERIALS

D.4 - When the Fiberglass installation passes and is holding integrity, Install all your Double Wall Penetration Fittings per their respective Installation Instructions. Re-Install the **SVA-BARB** to the schrader valves. Do **NOT** install fittings on joints.

IMPORTANT YOU MUST ABRADE THE SUMP WALLS FLAT PER THE **T-FS-SAND-KIT** INSTALLATION INSTRUCTIONS

WARNING DO NOT INSTALL PENETRATION FITTINGS ON OR NEAR FIBERGLASSED JOINTS. CONSULT THE FACTORY.

D.5 - After the Fittings have been installed and the sealant/adhesive has fully cured, pressure/soap test all fittings at 4 PSI.

NOTE: Vulkem Sealant must cure Overnight. This is used with Bravo Systems Flexible Penetration Fittings.

D.6 - When the Penetration Fitting installation passes and is holding integrity, You can begin installing pipe lines at this time or later.

E - MANDATORY AIR INTEGRITY TEST

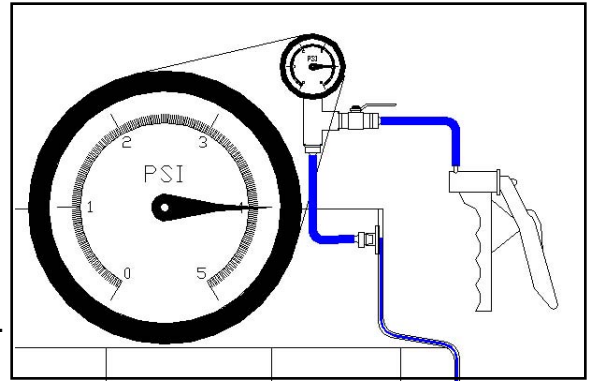

E.1 - Use test assembly and pressure sump to no more than **4 PSI**. Close off with ball valve and resume other work. Allow **1 Hour** before recording pressure.

NOTICE
BRAVO
QUALITY
STANDARD

FIELD AIR INTEGRITY INSPECTION TEST : Hold pressure for a minimum of 1 hour for a Field Integrity Inspection Test. The Tank Sump **PASSES** the integrity test if the Sump shows **NO** signs of continuous pressure decay.

IF TEST PASSES - CONTINUE ON TO THE HYDROSTATIC FILL & INTEGRITY TEST.

E.2 - IF ANY LEAKS ARE FOUND!!

Look at edges and corners for pinhole leaks. **For large leaks, consult factory.**

- A:** Locate leak point(s) and mark with marker so you can locate it / monitor it.
- B:** Repair or reinstall doublewall penetration fittings according to your doublewall penetration fitting manufacturers' Installation / Maintenance Instructions.
- C:** Abrade a 2" diameter area centered on the leak point until natural resin/fiberglass material can be seen. Dust with shop brush or compressed air and do not use shop towels or acetone on the abraded area(s). Then apply a 3-layer strip of 2" x 2" resin-saturated fiberglass mat squarely on the abraded area.
- D:** Roll out any air bubbles with chamfer roller. Let cure.
- E:** After cure, knock down fiberglass hairs, and apply another flow coat of resin only (**Step H.15**). Apply any extra resin to repaired leak point(s) while still wet. Let cure for a minimum of 4 hours @ or above 75° F.

FOR HYDROSTATIC MONITORING - PROCEED TO SECTION F.

FOR CONTINUOUS VACUUM MONITORING - The B400 DoubleWall Solid Series Sump cannot exceed 16" of Mercury. (Vacuum) Follow your vacuum system manufacturer's installation instructions to install, seal, and monitor the doublewall system with vacuum.



Connect the SVA-BARB to your factory-installed gauge for vacuum monitoring

Continue to Section I.

WARNING *Ensure that the fittings that are being used with the Vacuum Monitored System can withstand the amount of Vacuum your Monitoring System will generate.*

F - VACUUM / HYDROSTATIC FILLING

IMPORTANT

FIELD AIR INTEGRITY INSPECTION TEST :

YOUR PRODUCT WARRANTY WILL BE VOID IF YOU DO NOT Hold pressure for a minimum of 1 hour for a Field Integrity Inspection Test. *After passing the pressure test, it is HIGHLY RECOMMENDED that the 4 PSI is maintained for as long as possible, up until the time of backfill.*

WARNING

YOUR PRODUCT WARRANTY WILL BE REVOKED IF YOU CHOOSE TO SKIP THE AIR INTEGRITY TEST OUTLINED IN YOUR COPY OF YOUR PRODUCT INSTALLATION INSTRUCTIONS. YOU *MUST* COMPLETE THE PRESSURE TEST PRIOR TO HYDROSTATIC FILLING OF THE SUMPS.

The Bravo Double Wall product's ship from the factory with a combination gauge factory- installed and held under 20" of mercury / vacuum.

F.1 - After passing the Field Air Integrity Test per the Installation Instructions and there are no signs of leaks, you must cut the permanently affixed pipe plug from the tubing connected to the side wall. This is NOT the tubing with the gauge connected to it.

F.2 - Connect (newly cut) open end of tubing to barb-and-ball-valve assembly. (sold separately)
A 36" length of clear tubing is factory installed to the barb-and-ball-valve assembly.

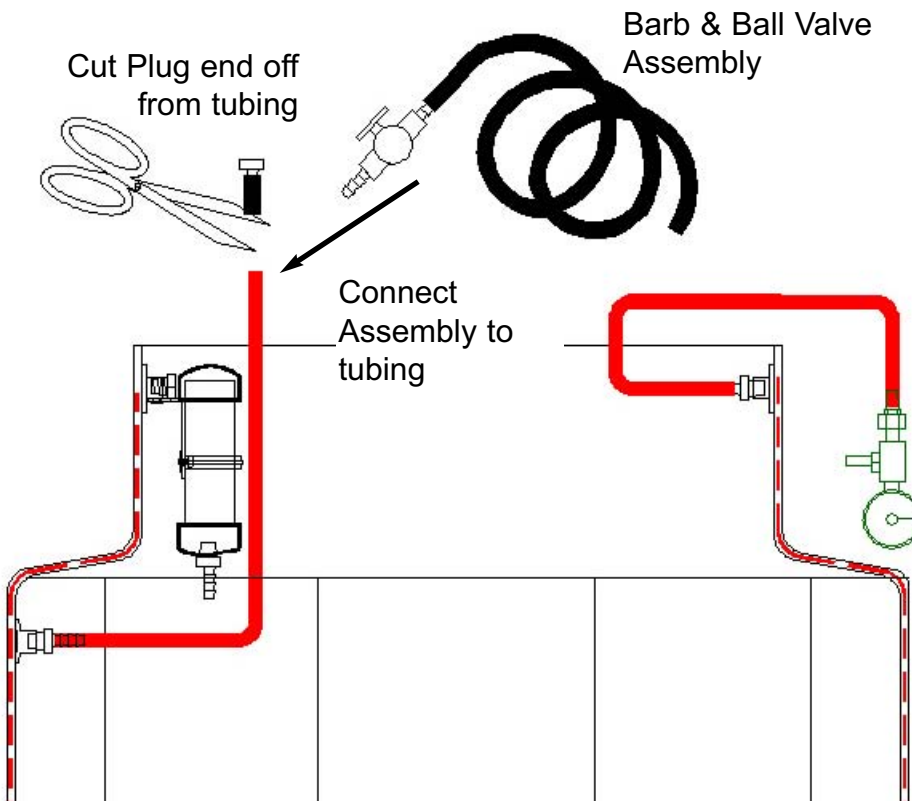

After the penetration fittings have been installed, the vacuum has been lost. Pressure/soap tests should have been conducted prior to filling the sumps with liquid.

You must cut off the barbed plug and connect the provided Barb & Ball Valve Assembly. Close off the ball valve and prepare the Venturi Vacuum Generator and air supply to be used to fill Sump with liquid.

F.3 - Close off ball valve completely and prime the open ended 36" length of clear tubing with provided Interstitial Fluid. Use a liquid funnel.



WARNING

Filling Bravo Systems Double Wall Products with Brine (saline) solution will void the product warranty. You must use only Bravo-Supplied Interstitial Fluid, part # IMF-1GAL

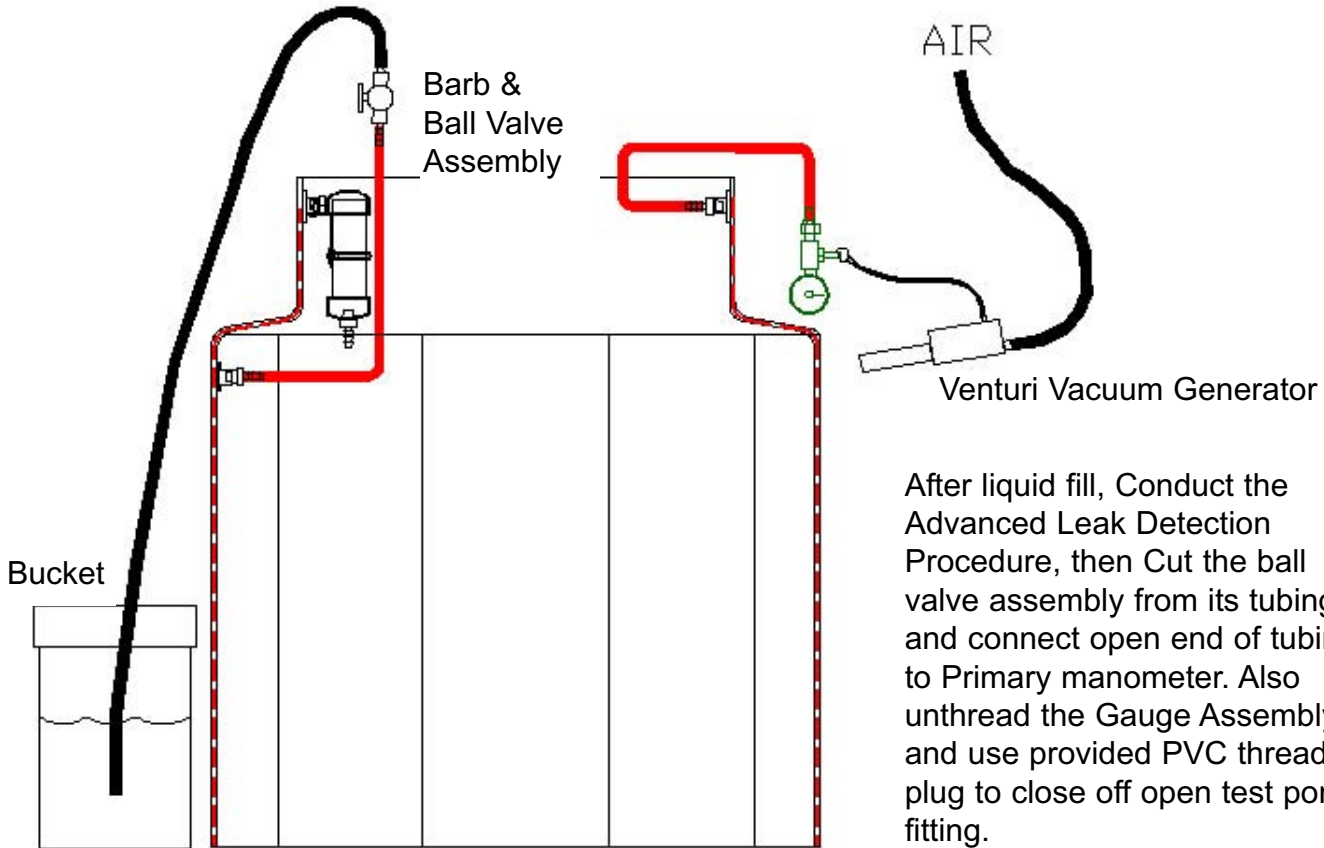

After liquid fill, Conduct the Advanced Leak Detection Procedure, then Cut the ball valve assembly from its tubing and connect open end of tubing to Primary manometer. Also unthread the Gauge Assembly and use provided PVC threaded plug to close off open test port fitting.

F.4 - After filling the tubing all the way to the ball valve, insert open end into your liquid source. (5 gallon bucket filled with fluid is recommended.)

F.5 - When ready, pull vacuum using the Venturi Vacuum Assembly (sold separately) to 20 Inches of mercury. Then **SLOWLY** open ball valve and allow Interstitial fluid to flow freely into the system at a rate of about 2 gallons a minute.

CRITICAL ...SLOWLY open ball valve...

F.6 - STOP PULLING VACUUM WHEN THE LIQUID IS 2-3 INCHES FROM THE VERY TOP OF THE INTERSTITIAL SPACE / TEST PORT. This is easily visible while filling the DoubleWall Product.

G) ADVANCED LEAK DETECTION PROCEDURE

A Bravo Systems Exclusive detection method

G.1 - Clear debris from the top open area of the DoubleWall Product and ensure that the interior walls are clean of debris and visible.

G.2 - Apply Vacuum to the sealed interstitial space with the Venturi Vacuum Assembly, and generate 20"-30" of vacuum for a *MINIMUM* of Five [5] Minutes.

WARNING

CHECK WITH YOUR EQUIPMENT MANUFACTURERS
INSTALLATION MANUALS FOR INSTALLATION
GUIDELINES AND/OR EQUIPMENT LIMITS REGARDING
VACUUM AND PRESSURE LEVELS.

G.3 - As stated in your Instructions, the liquid level is deliberately not filled to the very top of the interstitial space. This pocket of air is necessary to visually check the topmost level of liquid all the way around the Sump for indication of a leak.

G.4 - Visually inspect the interior walls for signs of trailing (very small) bubbles floating to the top of the liquid level within the interstitial space.

NOTICE

These air bubbles are visible within the vertical and horizontal channels of the walls. For Tank Sumps look below the reducer.

NOTICE

On the top hat reducer of a Tank Sump, any bubbles will burp consistently.

CRITICAL

PAY CLOSE AND SPECIAL ATTENTION TO FIELD-INSTALLED
PENETRATION FITTINGS and FRP JOINTS ON TANK SUMPS.
THESE ARE COMMON LEAK POINTS.

CAUTION

Even though Bravo DoubleWall product corners and edges are thicker than the rest of the Containment sump, These areas receive the most susceptible to physical damage by Installing Contractors. You would do well to be extremely careful with these DoubleWall products while storing, moving, transporting and Installing these critical environmental components.

ALDP IN ACTION DIAGRAM

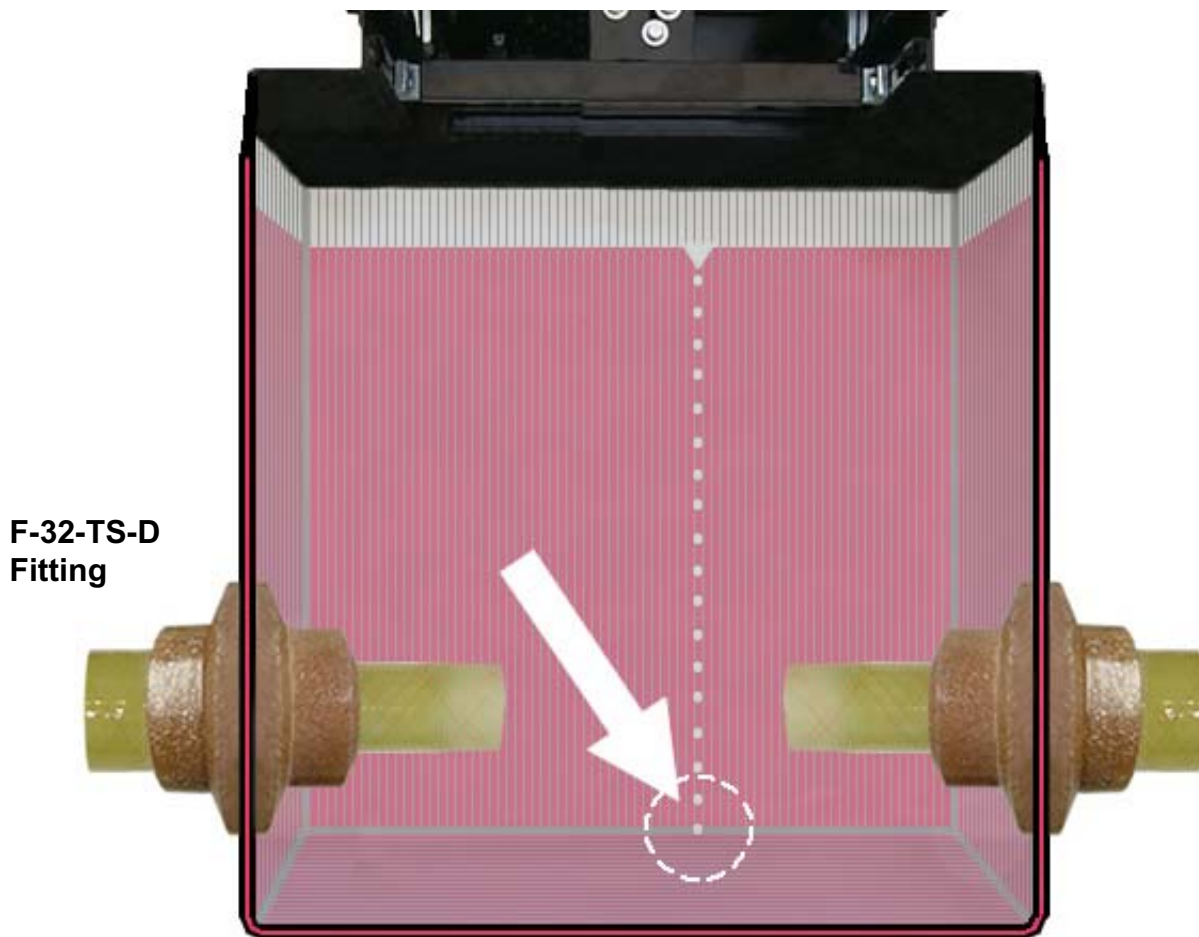

Here a leak is visible while a strong vacuum is pulled on the Interstitial space, forcing tiny air bubbles into the interstitial space to travel upwards. These streams of bubbles are easily spotted and can be traced down to its leak point or area.

▲ CRITICAL

PAY CLOSE AND SPECIAL ATTENTION TO FIELD-INSTALLED PENETRATION FITTINGS and FRP JOINTS ON TANK SUMPS. THESE ARE COMMON LEAK POINTS.

▲ CAUTION

Even though Bravo DoubleWall product corners and edges are thicker than the rest of the Containment sump, These areas receive the most susceptible to physical damage by Installing Contractors. You would do well to be extremely careful with these DoubleWall products while storing, moving, transporting and Installing these critical environmental components.

H - ATTACHING THE MANOMETER

H.1 - At this point, after the ALDP test, the interstice should still be holding vacuum. Maintain 20" of Vacuum and **slowly** open ball valve to let fluid into the interstice until it exits the venturi assembly. Visually check whether the fluid level reaches the top of the interstitial space.

H.2 - Cut the barb & ball valve assembly free by cutting the tubing just below it and **connect** open end of tubing to the bottom of the primary Manometer.

H.3 - **Remove the Barb**, Tubing & Combination gauge assembly from the test port fitting on the side of the sump. **Install a threaded pipe plug** into the open test port fitting and adjust Primary manometer bracket so the manometer is in a position clear of the sump cover.

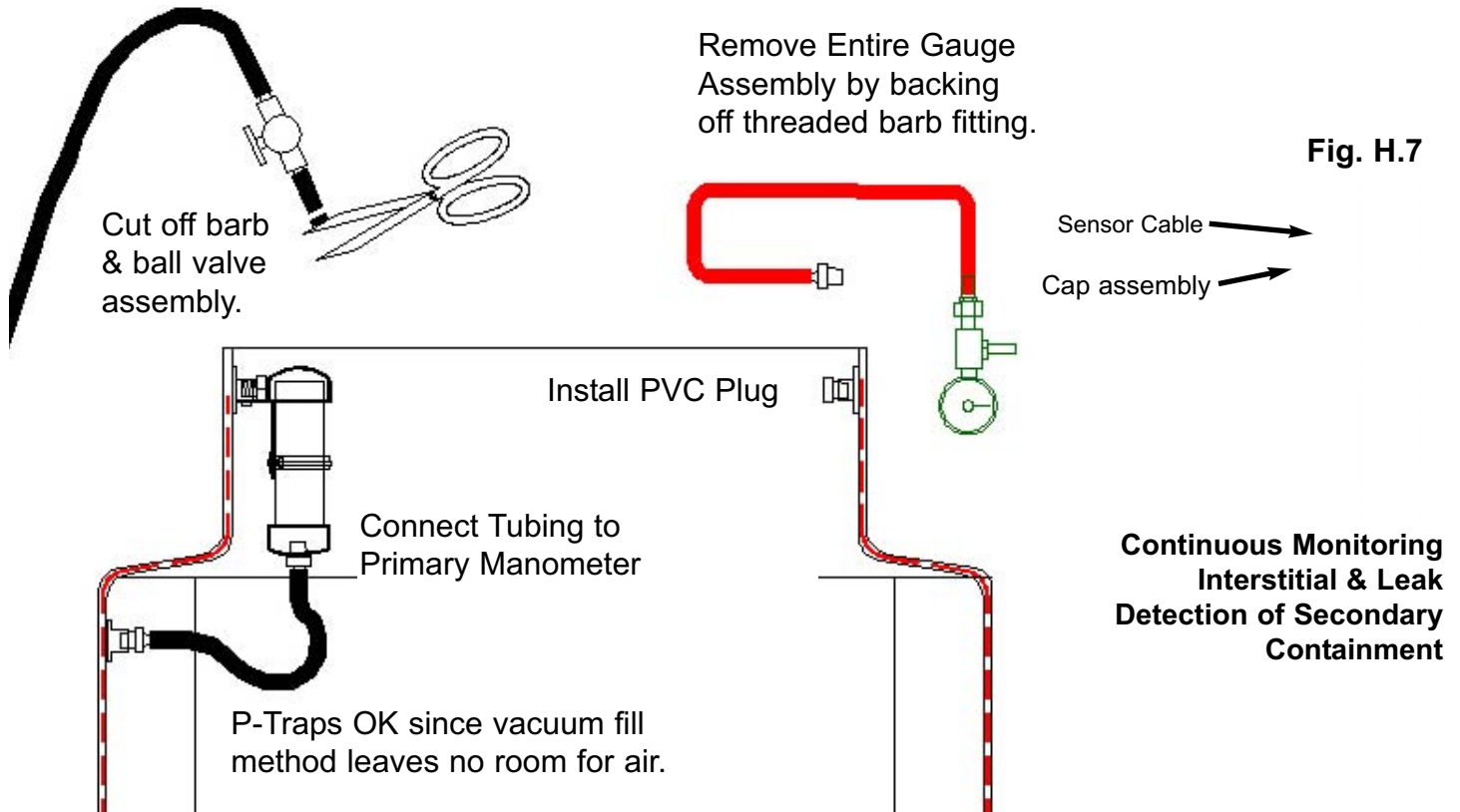

H.4 - It is not uncommon for some interstitial fluid to be lost while connecting the tubing to the primary manometer. This is ok. Replace lost fluid by topping off manometer with interstitial fluid until the liquid level reaches just 2 inches below the top of manometer.

H.5 - Hydrostatic Field Integrity Test - Mark the date and time of test and manometer level. **Allow 1 hour to look for a change in level.** No change in level or visible leaking means box passes test.

H.6 - If interstitial test fluid changes its level more than 1/4", visually look for any signs of leaking around fittings both interior and exterior to sump. Pay special attention to field installed fittings.

H.7 - If interstitial monitoring is required, install a California Listed Hydrostatic Sensor (LG-113) using the sensor manufacturer's fitting. Run sensor cable through the cap assembly (**see Fig. H.7**). Level sensor should be set to bottom of manometer. Follow your leak detector manufacturer's installation instructions. Cover the manometer with cap and fasten with wire and lead crimp seal.

I - Concrete and Backfill Guidelines.

To ensure that no immediate or future damage is done to your Bravo Tank Sump Reducer components, make sure that your manhole skirt **DOES NOT TOUCH OR REST ON THE TANK SUMP SHOULDER**. The Manhole Skirt should be kept at minimum of 4" away from the tank sump shoulder. Follow the manhole manufacturers instructions for installing the manhole. Also follow other details provided by tank and/or engineering firm for tank driveway pad installation.

Backfill your peagravel around the sump maintaining a minimum of 1' foot all the way around (if your site backfill is not entirely peagravel) and 4" minimum distance from the top edge of sump reducer.

When peagravel is in place, use a 3mil or thicker plastic sheet to cover the surface of the peagravel no less than 2 feet away from the sump reducer wall.

Secure this plastic barrier to the **EXTERIOR OF THE MANHOLE SKIRT** using duct tape. This prevents concrete from seeping too far down into the peagravel.

